



PCT and PPH: Friends or Foes?

FICPI Forum Rome

Rome
November 9 - 11
2011

Claus Matthes
Director, PCT Business Development Division, WIPO

The PCT

– 1970



- Basic idea: simplify the procedure for obtaining patent protection in many countries, making it more efficient and economical for:
 - users of the patent system: makes available a *filing tool for applicants* for foreign patent filings; and
 - patent offices: makes available a *tool for effective processing of patent applications by offices* of PCT Member States willing to exploit work done by others

The PCT — 1970



- Expectation: “**flying start**” for offices, work should be “rather in the nature of completing, checking and criticizing than starting from scratch in complete isolation”
- *PCT allows* offices to **re-use earlier work** (international reports) in a way which increases quality or reduces the amount of work needed to achieve same level of quality
 - **actual extent** to which this is done is a decision of the office or State concerned as a **matter of policy and efficiency**

PPH — today



- “PPH, through the exploitation of all the search/examination-related information of the OFF:
 - supports applicants in their efforts **to obtain stable patent rights efficiently around the world** and
 - **reduces the search/examination burden** and **improves the quality** of the examination of the major patent offices in the world”

(PPH Portal Site, <http://www.jpo.go.jp/ppph-portal/aboutpph.htm>)

PCT - PPH



PPH Patent Prosecution Highway

- Original PPH based on national work only

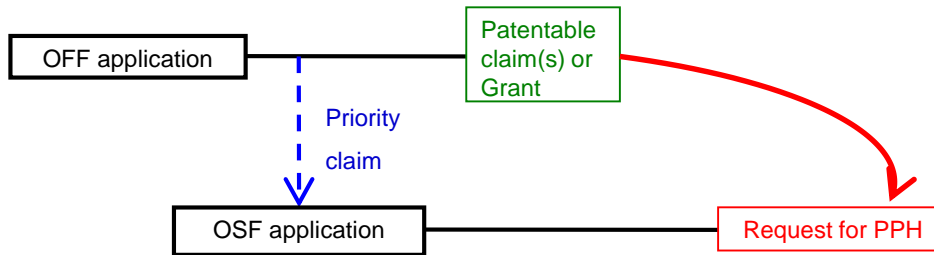

- PCT used as “vehicle”

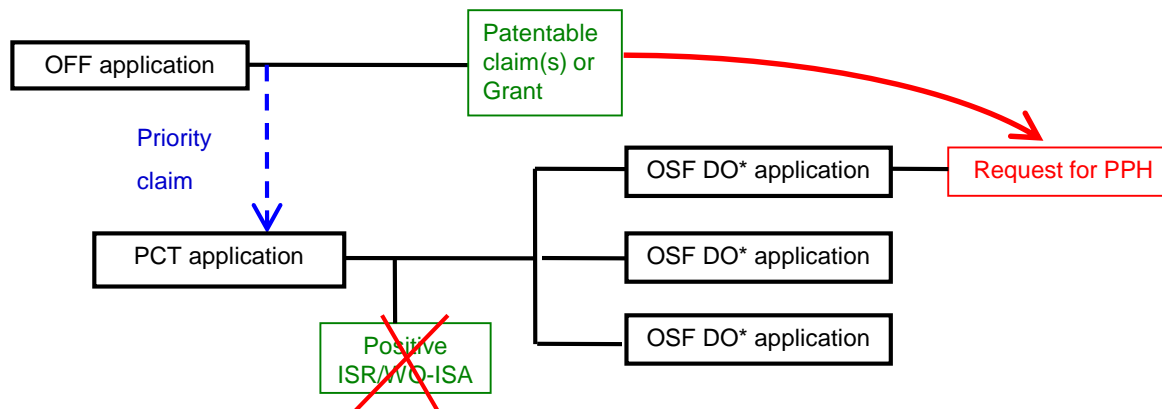

PCT - PPH



PPH Patent
Prosecution
Highway

- Fact that PCT work products were not included as basis for PPH request:
 - **catalyst for overdue discussions** by Member States on how well the PCT system is functioning
 -  **PCT Roadmap**

PCT Roadmap



- PCT extremely **successful as filing tool**; harmonization of formal and procedural requirements
- PCT **not as effective as work sharing tool** in practice for addressing national quality of examination and (for some offices) backlogs
- **No deficiencies in international legal framework**
 - rather: many national offices (notably those which act as both IA and DO) have **chosen** not to use PCT as it was intended

PCT Roadmap



- “Don’t reinvent the wheel; if it is broken, fix it”
- **Needed: change in approach** of offices vis-à-vis the PCT system, including a review of national procedures and practices and of what kind of incentives are set to use the system in a way which is beneficial to all

PCT Roadmap



- Which actions need to be undertaken to improve the PCT system so as to enable it to really fulfill its **role as *the work sharing tool of the international patent system***?
- PCT should
 - deliver results which meet the needs of applicants, offices, third parties in all Contracting States
 - without limiting freedom of Contracting States on substantive patent law matters

PCT Roadmap



- No significant changes to international standards
- Most Roadmap recommendations require **action by Offices individually**
 - Major action by **ISAs**, some by ROs
 - No obligations recommended on offices in their national capacities, but need to:
 - consider whether they can benefit more from system
 - give feedback to ensure system meets their needs

PCT Roadmap



- **Improve quality** and consistency of international reports:
 - Further improve quality management systems of IAs
 - Develop quality metrics for measuring usefulness
 - Explore collaborative search and examination
 - Set up third party observations system
 - Set up quality feedback system for offices
 - Record search strategies
 - Improve explanations of relevance of cited documents

PCT - PPH



PPH Patent Prosecution Highway

- PCT Roadmap discussions + demand by users + 2009 Trilateral Offices' **study on the re-use of ISR** (results confirmed by most recent PPH statistics) = PCT/PPH added

■ PCT/PPH:

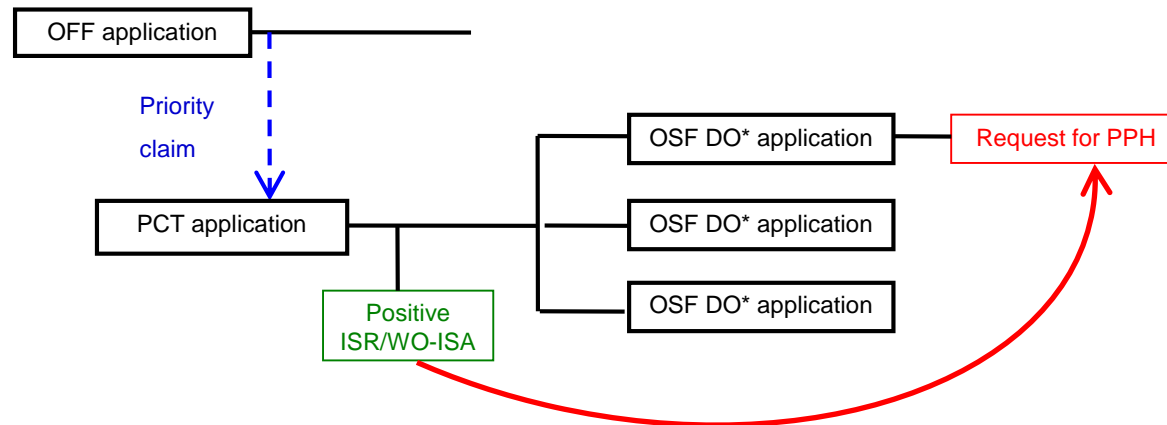

PCT - PPH



PPH Patent
Prosecution
Highway

- PCT/PPH **highly welcome** “add-on”, complements and completes the PCT procedure
- **Symbiotic** relationship:
 - PPH benefits from PCT timelines + timeliness of international work products
 - PCT benefits from additional incentive for applicants and offices to use the PCT system in a way which is beneficial to all:
 - high quality initial filing - increased chance of positive IPRP(I)
 - use of Chapter II; focus on fewer, high quality claims; quality and efficiency gains

PCT - PPH



PPH Patent Prosecution Highway

■ PCT/PPH agreements and unilateral actions:

- EP↔JP; EP↔US
- US↔JP; US↔KR; US↔AU; US↔FI; US↔ES; US↔RU; US↔AT; US↔SE; **US→US**
- JP↔FI; JP↔ES; JP↔SE; **JP→JP**; JP→MX
- AT↔FI
- FI↔RU; FI↔ES
- ES↔RU; ES↔KR
- **GB (any PCT Authority)**
- **CA→CA**
- **XN→US**

PPH

– “Spaghetti Bowl”

PPH Patent Prosecution Highway

(new)

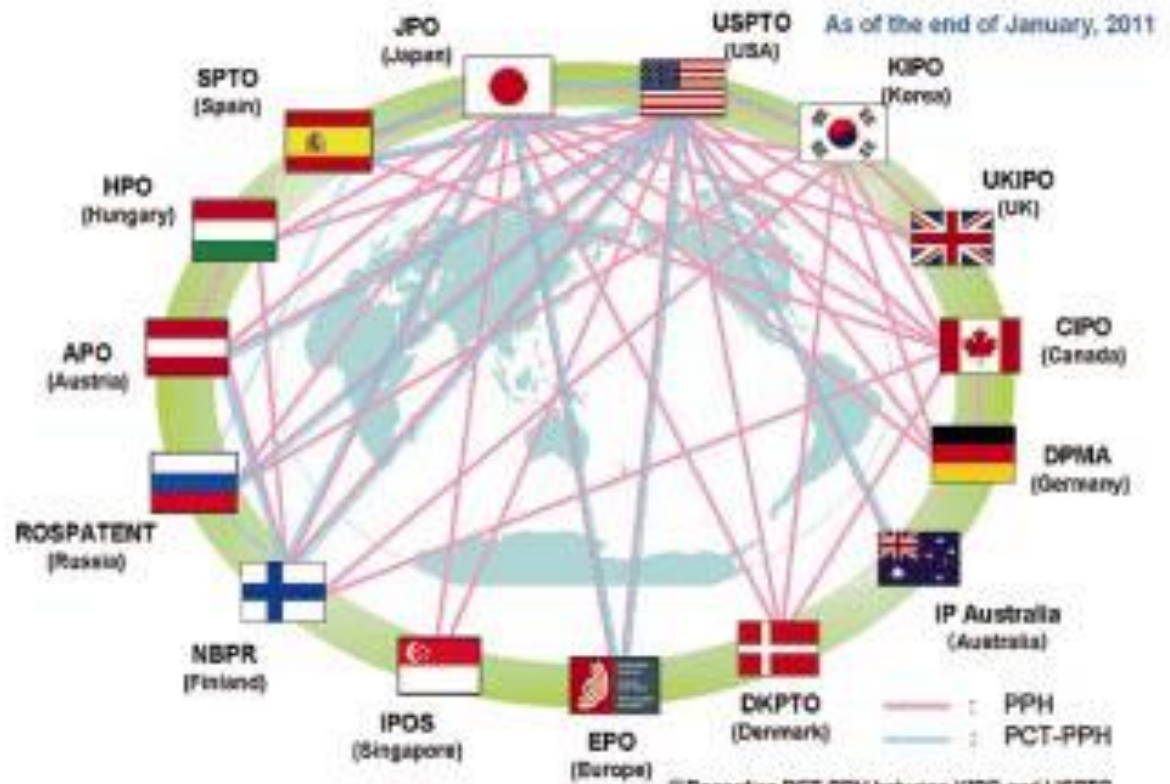

② Regarding PCT-PPH between KIPO and USPTO,
 KIPO (ISA/PEA) → USPTO program has launched.
 USPTO (ISA/PEA) → KIPO program has not launched yet.

PPH

— “Spaghetti Bowl”



(new)

- Web of **bilateral arrangements** between pairs of Offices
- **Differences** in:
 - practice
 - procedure
 - interpretation of basic requirements
 - Paris Convention PPH, PCT/PPH or both
 - Original PPH or PPH Mottainai

PPH

– Future Development



- “PPH 2.0”
- Agreement in principle on piloting **uniform conditions** and participation requirements
- Agreement in principle that all participating Offices will offer “**all-inclusive**” PPH: Paris Convention PPH and PCT/PPH
- Pilot by group of Offices to commence now and run for one year
 - AU, CA, EP, ES, FI, GB, JP, RU and US

PPH

— Future Development



(new)

- Piloting of **uniform PPH 2.0 conditions** and participation requirements, notably:
 - “Mottainai”
 - interpretation of “claim correspondence”
 - “self-certification” by applicant of claim correspondence
 - use of dossier access systems and machine translation to maximum extent possible

PPH

— Future Development



- What should be the **focus**?
 - Efficiency? Quality? Or both?
- **Applicant or Office** driven?
 - PPH – PCT/PPH
 - WIPO CASE; Trilateral CCD; Public file inspection; PCT seeking national phase reports
- Focus on **PPH, PCT/PPH or both**?
 - “Market share”
- **Timeliness**
 - PPH – PCT/PPH
- **Collaboration or sharing** of final products?
 - PCT pilot “Collaborative Search and Examination”

PPH – Future Development

PPH Patent
Prosecution
Highway



■ “Market share”

PCT percentage at IP5 Offices by IP5 Origins (2008)

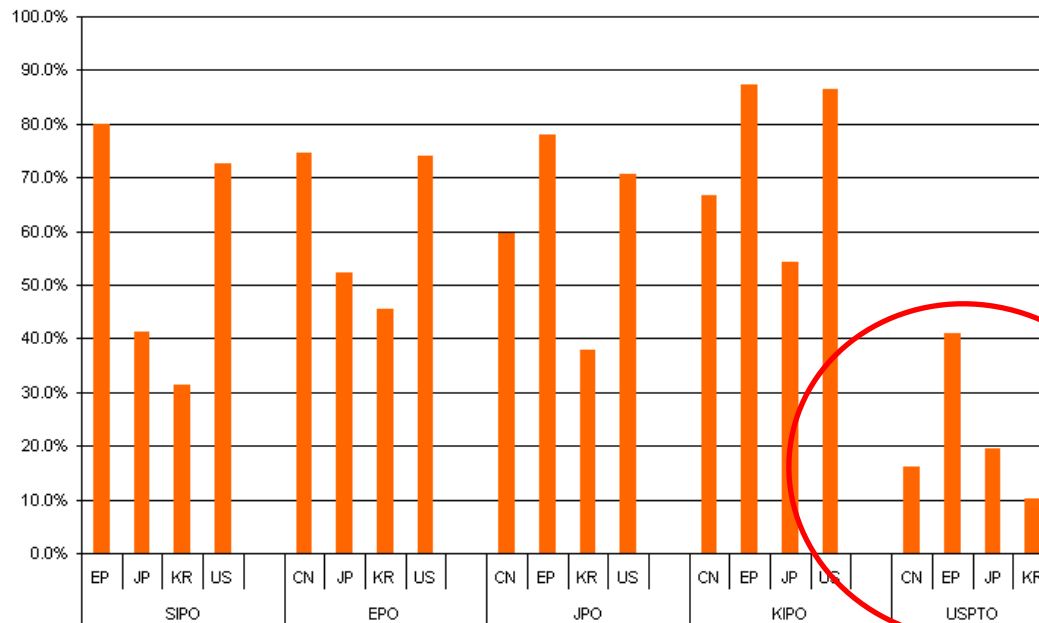

Impact of
changes to US law?

PPH – Future Development



■ Quality improvement:

- Are actions suggested in the PCT Roadmap correct?
- Are they achieving the desired results?
- Metrics are needed (EPN, Trilateral, IP5, PCT, PPH) which establish what can be re-used and its quality

■ Bilateral, Plurilateral, Multilateral?

- Role of WIPO?
- **Work sharing not (yet) a universally agreed concept!**

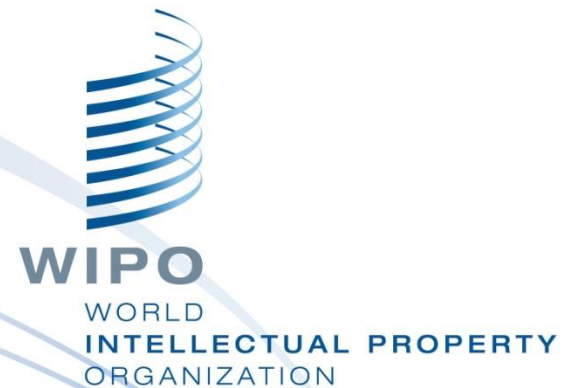

Thank You!

Claus Matthes

Director, Patent Cooperation Treaty (PCT) Business Development Division
World Intellectual Property Organization (WIPO)

34 chemin des Colombettes, 1211 Geneva 20, Switzerland
T +4122 338 98 09; claus.matthes@wipo.int; www.wipo.int